



सत्यमेव जयते

**FINAL REPORT ON ACCIDENT**

**INVOLVING**

**DIAMOND DA-42 AIRCRAFT VT-NFM**

**OPERATED BY**

**NATIONAL FLYING TRAINING INSTITUTE**

**ON 26/04/2017 AT GONDIA**

**Jasbir Singh Larhga**  
**Chairman, Committee of Inquiry**

**Dinesh Kumar**  
**Member, Committee of Inquiry**

## ***Foreword***

*In accordance with Annex 13 to the Convention on International Civil Aviation Organization (ICAO) and Rule 3 of Aircraft (Investigation of Accidents and Incidents), Rules 2012, the sole objective of the investigation of an accident shall be the prevention of accidents and incidents and not apportion blame or liability. The investigation conducted in accordance with the provisions of above said rules shall be separate from any judicial or administrative proceedings to apportion blame or liability.*

*This document has been prepared based upon the evidences collected during the investigation, opinion obtained from the experts and laboratory examination of various components. Consequently, the use of this report for any purpose other than for the prevention of future accidents or incidents could lead to erroneous interpretations.*

## INDEX

<b>Para</b>	<b>Content</b>	<b>Page No.</b>
	SUMMARY	02
1	FACTUAL INFORMATION	03
1.1	HISTORY OF THE FLIGHT	03
1.2	INJURIES TO PERSONS	05
1.3	DAMAGE TO AIRCRAFT	05
1.4	OTHER DAMAGE	05
1.5	PERSONNEL INFORMATION	06
1.5.1	PILOT – IN – COMMAND	06
1.5.2	CO-PILOT	07
1.6	AIRCRAFT INFORMATION	08
1.7	METEOROLOGICAL INFORMATION	12
1.8	AIDS TO NAVIGATION	12
1.9	COMMUNICATIONS	12
1.10	AERODROME INFORMATION	13
1.11	FLIGHT RECORDERS	14
1.12	WRECKAGE AND IMPACT INFORMATION	14
1.13	MEDICAL AND PATHOLOGICAL INFORMATION	20
1.14	FIRE	20
1.15	SURVIVAL ASPECTS	20
1.16	TESTS AND RESEARCH	21
1.16.1	ENGINE STRIP EXAMINATION	21
1.17	ORGANISATIONAL AND MANAGEMENT INFORMATION	31

1.17.1	NATIONAL FLYING TRAINING INSTITUTE (NFTI)	31
1.17.2	POLICY AND PROCEDURE	32
1.17.3	SAFETY REPORTING	33
1.18	ADDITIONAL INFORMATION	34
1.18.1	AIRCRAFT PERFORMANCE DATA	34
1.18.2	ATC TRANSCRIPT	35
1.18.3	DGCA FLYING GRANT CIRCULAR NO. 2/2005	37
1.19	USEFUL OR EFFECTIVE INVESTIGATION TECHNIQUES	37
2	ANALYSIS	40
2.1	SERVICEABILITY OF AIRCRAFT	40
2.2	CERW QUALIFICATION	41
2.3	WEATHER	41
2.4	FLIGHT DATA ANALYSIS	42
2.5	CIRCUMSTANCES LEADING TO THE ACCIDENT	42
3	CONCLUSIONS	43
3.1	FINDINGS	43
3.2	PROBABLE CAUSE OF THE INCIDENT	45
4	RECOMMENDATIONS	45

**FINAL REPORT ON ACCIDENT INVOLVING DIAMOND DA-42**  
**AIRCRAFT VT-NFM OPERATED BY NATIONAL FLYING TRAINING**  
**INSTITUTE, GONDIA ON 26/04/2017 AT GONDIA**

- |                              |   |
|------------------------------|---|
| 1. Aircraft Type             | : Diamond DA-42   |
| Nationality                  | : INDIAN  |
| Registration                 | : VT –NFM   |
| 2. Owner                     | : National Flying Training Institute,<br>Gondia                               |
| 3. Operator                  | : National Flying Training Institute,<br>Gondia                               |
| 4. Pilot – in –Command       | : CPL holder on type,   |
| Extent of injuries           | : Fatal   |
| 5. First Officer             | : SPL Holder  |
| Extent of injuries           | : Fatal   |
| 6. Place of Incident         | : Village Dhapewada, Gondia   |
| 7. Date & Time of Incident   | : 26 <sup>th</sup> April 2017, 0402 UTC                                       |
| 8. Last point of Departure   | : Gondia Airport  |
| 9. Point of intended landing | : Gondia Airport  |
| 10. Type of operation        | : Training  |
| 11. Crew on Board            | : 02  |
| 12. Phase of operation       | : Cruise  |
| 13. Type of incident         | : Aircraft hit a Ropeway cable while<br>flying low and crashed on a river bed |

(ALL TIMINGS IN THE REPORT ARE IN UTC)

## **SUMMARY**

Diamond DA-42 aircraft, registration VT-NFM belonging to M/s National Flying Training Institute was involved in an accident at Gondia on 26.04.2017, wherein the flying instructor and the trainee pilot were fatally injured and aircraft was completely destroyed after it crashed on a river bed.

The Flying instructor and the trainee pilot were scheduled for local flying in Gondia Sector West on 26.04.2017. Aircraft, took off from RWY 04 after take-off clearance from ATC and turned left as per normal departure procedure to intercept radial R265 as per departure clearance.

Crew reported intercepting radial R265 at 10 NM when the aircraft was at 4000ft. At 0400 UTC, ATC instructed crew to climb to 5000 feet, operate 17 NM to 25 NM and report all operations normal at every 10 minutes. Crew acknowledged the call and this was the last transmission from the aircraft.

Thereafter, the aircraft did not make any contact with ATC. The information about aircraft crash was received by NFTI at 0410 UTC. The information was passed onto ATC and search & rescue was activated. The wreckage of aircraft was located on the bed of River Wainganga near Village Dhapewada. The aircraft had hit the ropeway cable causing the upper area of cockpit and tail to shear off and aircraft to crash on to the ground at about 190 meters away from the rope way. The location is 11.8 NM from Gondiaairport on radial R281.

Occurrence was classified as Accident as per the Aircraft (Investigation of Accidents and Incidents) Rules, 2012. Committee of Inquiry was appointed by Ministry of Civil Aviation vide its notification Ref AV.15013/02/2017-DG appointing Mr. Jasbir Singh Larhga, Assistant Director, AAIB as Chairman and Mr. Dinesh Kumar, Air Safety Officer, AAIB as Member.

Initial notification of the occurrence was sent to ICAO, Transport Safety Board of Canada and NTSB, USA on 26<sup>th</sup> April 2017 as per requirement of ICAO Annex 13. TSB, Canada appointed Mr. Beverley Harvey as an Accredited Representative under ICAO Annex 13.

## **1. FACTUAL INFORMATION**

### **1.1 History of the flight:**

On 26.04.2017, a Diamond DA-42 aircraft, registration VT-NFM belonging to National Flying Training Institute (NFTI), was scheduled to operate in sector west for local flying. The flight was an Instrument Flying sortie, to be operated by a Flight Instructor and a Student Pilot as part of flying training exercise for student pilot. The expected duration of the flight was 01Hrs and 20 minutes. The ETD was 0330 UTC as per the Flight Authorisation register, however actual departure was delayed. A total of 09 training sorties were planned for the day including the one operated by VT-NFM. The flying on the day of accident was authorised by Dy. Chief Flight Instructor (Dy. CFI), in absence of Chief Flight Instructor (CFI) in accordance with CAR Section 7, Series I, Part V.

The student pilot got her pre-flight medical check done at 0225 UTC after group briefing. The pre-flight medical check for the Instructor was carried out at 0337 UTC. During pre-flight briefing crew obtained weather from ATC Gondia for 0330 UTC. The reported weather as per NFTI records was; visibility 4000 meters in haze and 07Kt winds from 330° north west direction .Flying was being carried out under special VFR.

The first departure of the day from Gondia was VT-NFB which departed at 0330 UTC. The second planned departure of the day was VT-NFL, which departed at 0345 UTC. VT-NFM was the third departure of the day. After completing pre-flight preparations, crew walked to the aircraft at around 0343 UTC. At 0344 UTC crew requested ATC for start-up and the same was granted by ATC.

After start-up, the crew requested permission for TAXI at 0346 UTC. The ATC granted TAXI permission and clearance to holding point RWY 04 via P2 while following company aircraft VT-NFL. The crew acknowledged and later informed ATC that VT-NFM will be ahead of VT- NFL and same was coordinated with VT-NFL.

At 0350 UTC crew requested for sector clearance. The aircraft was cleared for general flying in sector west, departing RWY 04 climbing 2500 feet, turning left to establish Radial R265 GDA, and further climb to 5000 feet.

At 0351UTC crew requested for line up behind landing aircraft and then lined up after permission from ATC. Crew requested take-off clearance at 0353 UTC and took off after clearance by ATC. Crew gave calls to indicate that it was following the circuit -leaving procedure for Sector West.

As per the ATC records, crew reported level 4000 to ATC at 0357 UTC and reported intercepting radial R265 at 03 NM. Again at 0359 UTC crew reported position 4000 feet on radial R265 at 10 NM out. ATC instructed crew to climb to 5000 feet, operate 17 NM to 25 NM and report all operations normal at every 10 minutes. Crew acknowledged the call at 0400 UTC. This was the last call from crew.

At 0403 UTC, ATC called the aircraft to advise traffic, however the crew did not copy back or give confirmation. There was no further call from ATC either.

Thereafter, the aircraft did not make any contact with ATC. At approximately 0410 UTC, a Flight Dispatcher at NFTI received a call informing her about the information received from one of the relative of NFTI employee, about an aircraft crash. The information was passed onto the ATC. At 0422 UTC ATC tried calling the aircraft, but got no response. Even after repeated calls, no response was received.

At 0424 UTC, ATC gave call to another company aircraft operating in the same control zone to establish VHF contact with the aircraft. However, there was no response. At 0429 UTC Mumbai FIC and Nagpur ATC were also informed. Gondia ATC than instructed another company aircraft VT-NFC to proceed to sector west and try to contact the aircraft at 0432 UTC.



At 0513 UTC VT-NFC confirmed aircraft crash to Gondia ATC. In the meanwhile the search & rescue team from NFTI had already moved to the reported crash site.

The wreckage of aircraft was located on river bed of Wainganga river near Village Dhapewada. The location is about 11.8 NM from Gondia airport on radial R281. Both pilots had received fatal injuries in the crash.

As per the witness statements and evidences at crash site, the aircraft was flying at a height of 60-70 feet from the river bed when it hit the ropeway cable.

The impact with the cable caused the upper area of cockpit and tail to shear off. The aircraft after hitting the steel cable of ropeway, fell on ground at about 190 meters away from the rope way. The wreckage was scattered in an area of 150X200 meters approximately.

### **1.2 Injuries to persons**

<b>INJURIES</b>	<b>CREW</b>	<b>PASSENGERS</b>	<b>OTHERS</b>
FATAL	02	Nil	Nil
SERIOUS	Nil	Nil	Nil
MINOR	Nil	Nil	Nil

### **1.3 Damage to Aircraft :**

The top area of cockpit and tail of the aircraft was sheared off after impact with the steel cable of the ropeway. The aircraft fell on the river bed and was completely destroyed.

### **1.4 Other damage:**

The aircraft had hit a steel ropeway cable before dropping down. The ropeway cable stayed intact. The aircraft also brushed against a boat on the river bed.

## 1.5 Personnel information

### 1.5.1 Pilot – in – Command

AGE	:	47 years 03 months
License	:	CPL Holder
Category	:	Aeroplane
Validity of License	:	19.11.18
Endorsements as PIC	:	Cessna 172R, DA-40, DA-42
Date of Med. Exam.	:	18.02.2017
Med. Exam valid upto	:	10.09.2017
FRTTO License Validity	:	01.07.2018
Total flying experience	:	3238:55 Hrs
Experience on type	:	271:30 Hrs
Total flying experience during last 365 days	:	645:35 Hrs
Total flying experience during last 180 days	:	419:25Hrs
Total flying experience during last 30 days	:	115:55Hrs
Total flying experience during last 07 Days	:	25:45 Hrs
Total flying experience during last 24 Hours	:	05:30 Hrs

The PIC was ex-defence pilot who joined NFTI in March 2014 as a Ground Instructor. He was later approved as Chief Ground Instructor in May 2015. He did not meet the requirements for grant of FIR (A) { Flight Instructor Rating (Aeroplane) } because he did not meet the following requirements laid in Section R of Schedule II of Aircraft Rules 1937.

*“(a) twenty hours by night during which at least twenty take-offs and twenty landings have been carried out;*

*(b) three hundred hours of flight time on aeroplanes or one hundred fifty hours on helicopters, as the case may be, satisfactorily completed in the capacity of an Assistant Flight Instructor or Qualified Flight Instructor in the service of Defence Forces.”*

A request for exemption under Rule 160 of Aircraft Rules, 1937 to allow the pilot to carry out instructional flying without valid FIR (A) was submitted by NFTI to DGCA. Exemption was granted vide letter dated 16.03.2016 for a period of 06 months. He started exercising the privileges of FIR(A) and started instructional flying in June 2016. He continued to impart instructional flying with exemption granted under Rule 160 till it lapsed in September 2016, however during the exempted period, he was unable to complete 300 Hrs of flying on type. Exemption was again granted in Dec 2016 for another 06 months. Formal application for Flight Instructor Rating was submitted to DGCA on 21.04.2017 after completion of flying hours. The application was still under consideration on the date of accident.

### 1.5.2 Co-Pilot

AGE	:	23 years 11 months	
License	:	SPL Holder	
Category	:	Aeroplane	
Validity	:	18.10.2020	
Aircraft Ratings	:	DA-40, DA-42	
FRTTO License Validity	:	17.01.2026	
Date of Med. Exam	:	30.05.2016	
Med. Exam valid upto	:	03.06.2017	
Total flying experience	:	198:55 Hrs	
Experience on type	:	13:40 Hrs	
Total flying experience during last 365 days	:	172:30 Hrs	
Total flying experience during last 180 days	:	140:55Hrs	
Total flying experience during last 30 days	:	36:30 Hrs	
Total flying experience during last 07 Days	:	08:40 Hrs	
Total flying experience during last 24 Hrs	:	01:00Hrs	

Co-pilot joined NFTI in Sept 2015 under a cadet program to undergo flying training for grant of CPL. She commenced flying in December 2015 and operated

her first solo flight in March 2016. She was operating last sortie before completing 200 hrs of flying training for grant of CPL.

Both the operating crew were not involved in any serious incident/ accident in past. Both the operating crew were current in all training and had adequate rest as per the Flight Duty Time Limitations (FDTL) requirement prior to operating the accident flight.

### 1.6 Aircraft Information:

The Diamond DA-42 aircraft is a twin-engine, low-wing cantilever monoplane, commonly used as a general aviation aircraft for touring and training purposes. It is equipped with a retractable tricycle landing gear arrangement and uses a T-tail. The airframe is mainly composed of carbon fibre reinforced polymers throughout its structure.

The DA-42 aircraft can accommodate 02 pilots along with two passengers who can be seated behind each of the pilots. All of the seats have automotive-style three-point seat belts; while the seats themselves are fixed in position, the position of the rudder-pedals is adjustable.

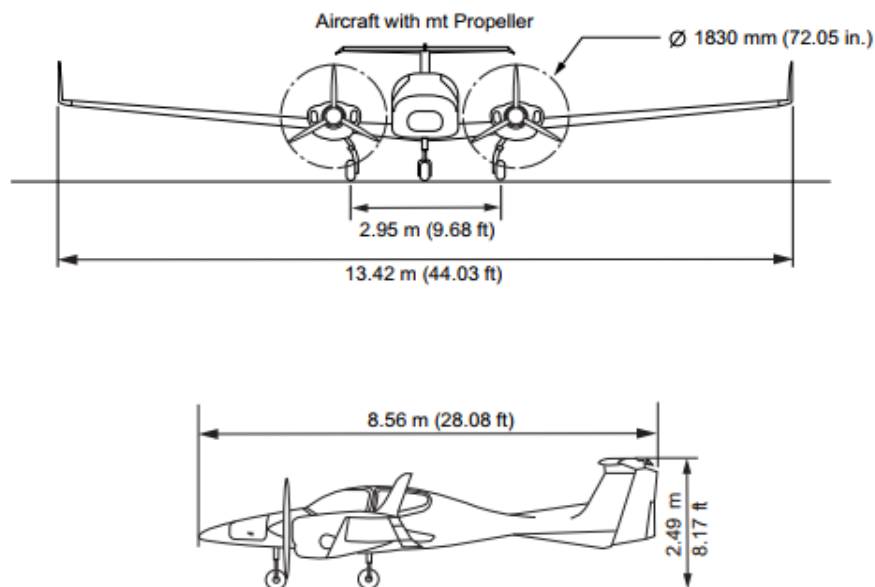

**Fig 1: Front and Side view of DA-42 aircraft**

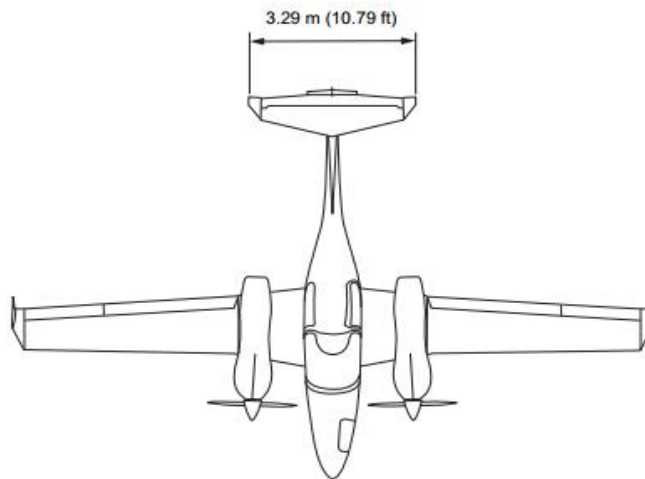

**Fig 2: Top View of DA-42 aircraft**

The front pair of seats are accessed via a front-hinged canopy which provides broad external view to pilots while a top-hinged door located on the left side provides access to the rear seats. A single combined power lever is used to regulate both the engine and propeller settings.

The DA42 aircraft is fitted with Garmin G1000 glass cockpit. The G1000 Integrated Avionics System has a fully integrated flight, engine, communication, navigation and surveillance instrumentation system.

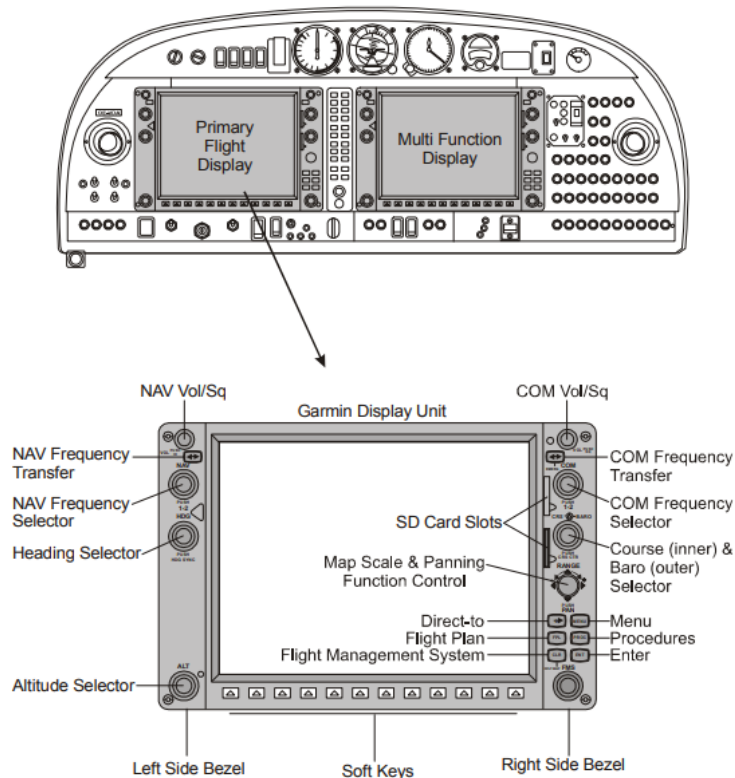

**Fig 3: Garmin G1000 glass cockpit & SD card slot**

The system consists of a Primary Flight Display (PFD), Multi-Function Display (MFD), audio panel, Air Data Computer (ADC), Attitude and Heading Reference System (AHRS), engine sensors and processing unit (GEA) and integrated avionics (GIA) containing VHF communications, VHF navigation and GPS (Global Positioning System). SD card slots are provided on the Primary Flight Display. SD card can be used to record and download flight parameters. The DA42 is also fitted with Garmin-built GFC 700 autopilot and GWX 70 weather radar.

Aircraft VT-NFM (MSN:42 AC145) was manufactured in year 2009. The aircraft was registered with DGCA under the ownership of M/s National Flying Training Institute Pvt Ltd. The aircraft is registered under Category 'A' and issued Certificate of registration No. 4088 on 29.07.2010.

The Certificate of Airworthiness Number 6197 under "Normal category" subdivision "Passenger" was issued by DGCA on 29.07.2010. The specified minimum operating crew is "one" and the maximum all up weight is 1785Kgs. At the time of accident the Certificate of Airworthiness (CoA) was current and valid until unless suspended/cancelled subject to validity of Airworthiness Review Certificate (ARC). ARC was issued on 13.10.2016 and was valid upto 15.10.2017.

The Aircraft was holding Aero Mobile License No A-051/008/WRLO-10 at the time of accident which was valid up to 31.12.2017.

The aircraft and its engines are being maintained as per the maintenance program consisting of calendar period/ flying Hours or Cycles based maintenance as per maintenance program approved by Directorate General of Civil Aviation (DGCA).

Accordingly, the last major inspection was 200 hrs/12 month and was carried out on 08.04.2017. Subsequently all lower inspections (Pre-flight checks, Service Checks, Weekly Checks) were carried out as and when due before the accident.

The aircraft was last weighed on 16.08.2016 and the weight schedule was prepared and duly approved by the DGCA. As per the approved weight schedule the Empty weight of the aircraft is 1262.475 Kg. Maximum Usable fuel Quantity is 208.224 Kg. Maximum payload with fuel tanks full is 123.981 Kg. Empty weight CG is 2.437 meters aft of datum.

All the concerned Airworthiness Directive, mandatory Service Bulletins, DGCA Mandatory Modifications on this aircraft and its engine were complied with as on date of event.

The aircraft was equipped with Lycoming IO-360 M1A engines. The left engine S/N L-32168-51E was manufactured in Feb 2014 and had logged 4227 Hrs since new and 1248:25 Hrs since last overhaul. The right engine S/N L-1144-67E was manufactured in Feb 2014 and had logged 3199:00 Hrs since new and 1248:25 Hrs since last overhaul on the day of accident. The last major inspection on both engines was 200 hrs/12 month inspection and was carried out on 08.04.2017.

The aircraft is fitted with two MT propellers. The details of the propellers are given below:

	Engine # 1	Engine # 2
Propeller Model	MTV	MTV
Serial Number	120408	100191
Part Number	MTV-12-B-C-F/CF183-59b	MTV-12-B-C-F/CFL183-59b
TSN	1698:35 Hrs	1684:20 Hrs
TSO	126:50 Hrs	120:50 Hrs

Propeller fitted on both the engines were next due for overhaul at, 4927:15 Hrs aircraft TSN or 10.03.2023, whichever was earlier and was complying with all modifications at the time of accident on both the propeller.

### 1.7 Meteorological information:

NFTI obtained weather from Gondia airport over telephone and from Nagpur, Raipur and Jabalpur over internet and recorded the weather in its METAR record.

The scrutiny of MET record showed that the on 26-04-2017 at 0330 UTC the visibility was 4000 m and winds were 330/07 Kt.

Time (UTC)→	0330	0400	0430
Wind	330/07	330/07	320/11
Visibility	4000 M in Haze	4000 M in Haze	5000 M in Haze
Clouds	No significant clouds		
Temp	34.4 °C	34.4°C	37°C
Dew Point	14.3°C	14.3°C	13°C
QNH	1010 hPa	1010 hPa	1010 hPa

The operations were being carried out under Special VFR as permitted by DGCA Flying Grant Circular No.2/2005 dated 12.04.2005. However, CFI was not present during flying as required by the circular.

### 1.8 Aids to navigation:

Gondia airport is equipped with DVOR (frequency 114.2 MHz), DME (frequency 1113/1176 MHz) and NDB (frequency 230 kHz). PAPI & ILS CAT-I is installed on Runway 04 and runway 22 is facilitated with PAPI only.

### 1.9 Communications:

The Communication frequencies available at Gondia are 118.35 MHz, VHF ALT 118.7 MHz, VHF Emergency 121.5 MHz and DATIS Broadcast is at 126.8 MHz.

Aircraft was in positive communication with ATC on Tower frequency 118.35MHz.



## 1.10 Aerodrome information

Aerodrome is situated at Birsi Village in Gondia, Maharashtra. The Aerodrome is operated by Airport Authority of India. There are no schedule flights being operated to Gondia. The airport is primarily used for flying training by NFTI and is equipped with night operation facility. The aerodrome layout is given in figure below.

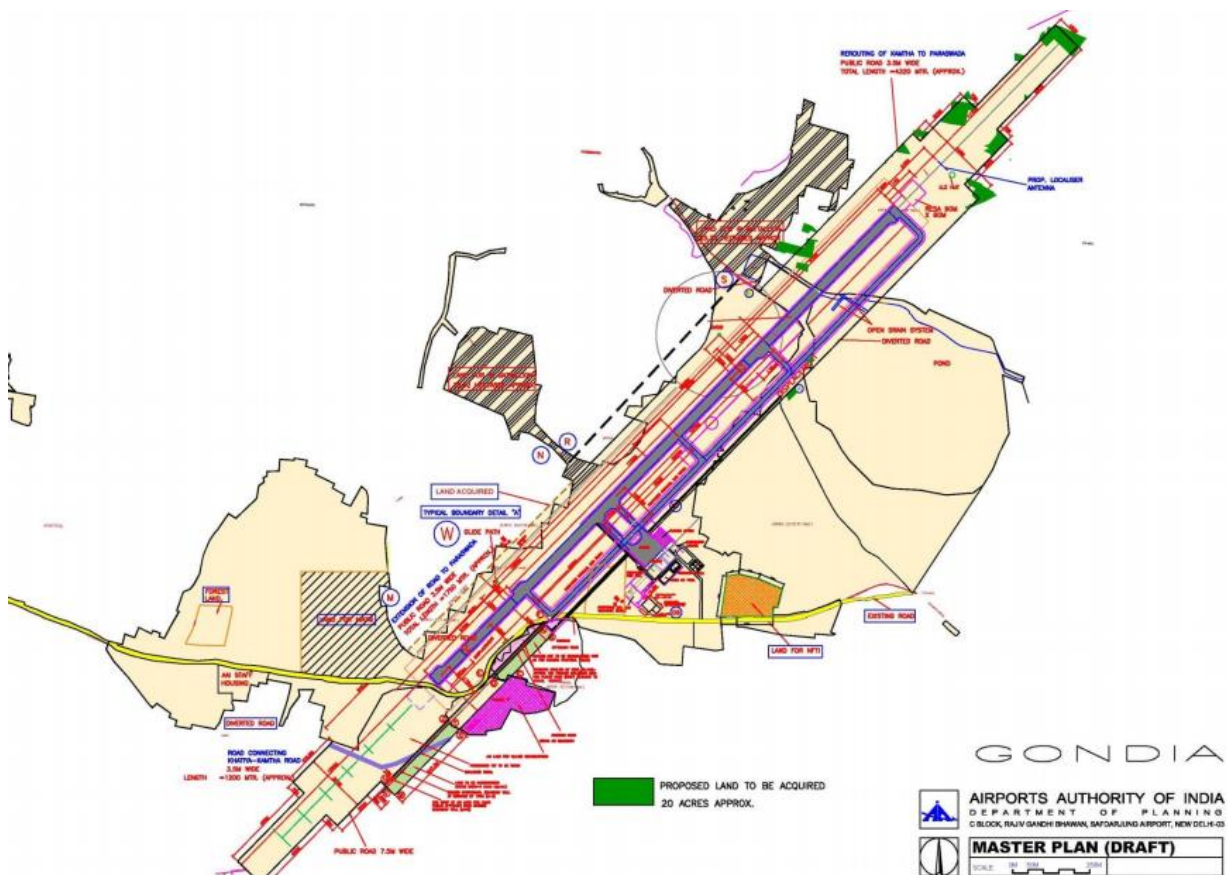

**Fig: 4 Aerodrome Layout**

The geographical co-ordinates of the airport are 21°31'24.78"N and 80°17'15.66"E. The elevation of the airport is 301 m (AMSL). The runway is 2290 m in length and 45 m in breadth. The orientation of the runway is 04/22. The detail of runway distances is as below:

Rwy No.	Code	Elevation	TORA (M)	TODA (M)	ASDA (M)	LDA (M)
04	4C	301m	2290	2290	2290	2135
22	4C	301m	2290	2290	2290	2155

### **1.11 Flight recorders:**

Aircraft was not equipped with DFDR or CVR recorder. However, aircraft was equipped with GARMIN equipment, which could be used to record flight parameters on a SD Card. This was primarily for purpose of monitoring training. The SD card was however not fitted on this aircraft as the software was not updated to allow download of flight parameters.

The facility was available on another DA-42 aircraft available with NFTI. Data from that aircraft was downloaded and analysed for flights operated by the deceased Instructor. Data analysis revealed a few instances of low flying by the deceased Instructor. The observations from flight data was corroborated by statements from cadet pilots and it was revealed that Instructor had at some instances carried out low flying and breached assigned flight levels, during sorties with other cadet pilots, which were incidentally the last sorties of these cadet pilots.

### **1.12 Wreckage and impact information:**

The aircraft had impacted a steel cable of approximately 02 inches thickness. This impact caused the top area of cockpit and tail to be sheared off. The sheared tail caused the aircraft to lose its stabilizer, pitch down and hit the ground.



**Fig 5: Aircraft Wreckage at crash site**

The aircraft's final position was 190 meters away from the point of impact. Before reaching its final position aircraft grazed the base of a boat on the river bed and toppled.

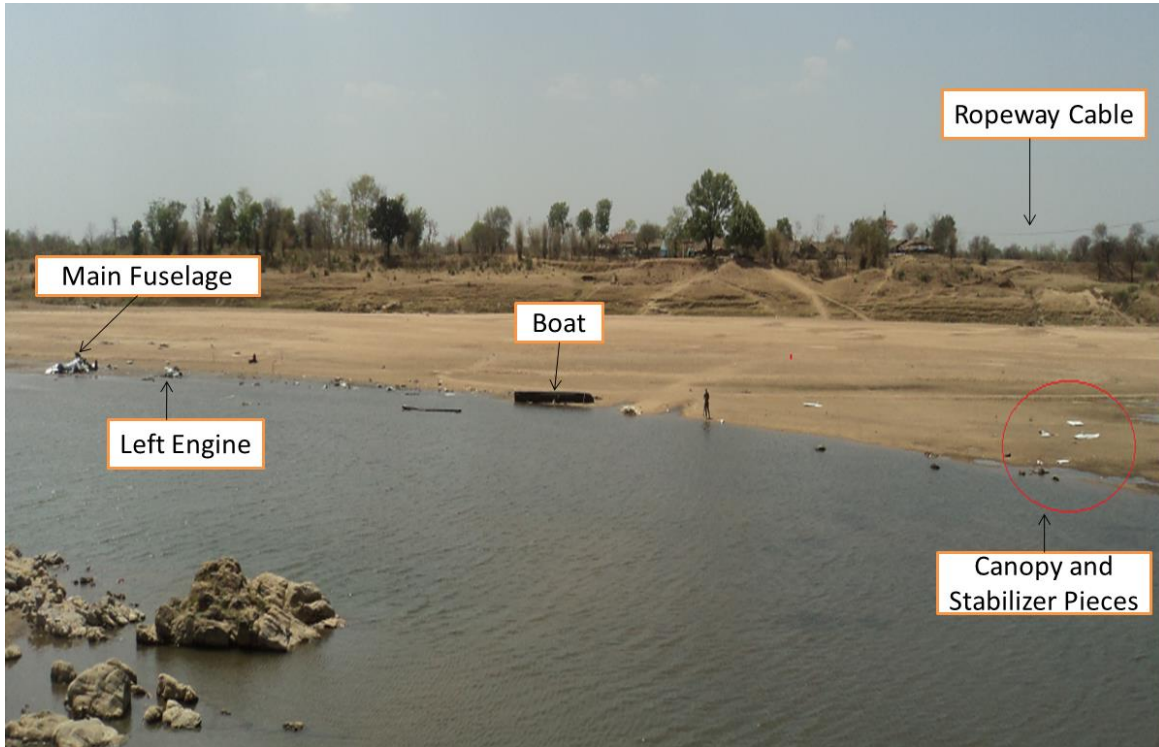

**Fig 6: Crash Site**

The wreckage was recovered from the accident site and shifted to a hangar at Gondia Airport. Layout of wreckage was carried out to carry out detailed study of the damage.

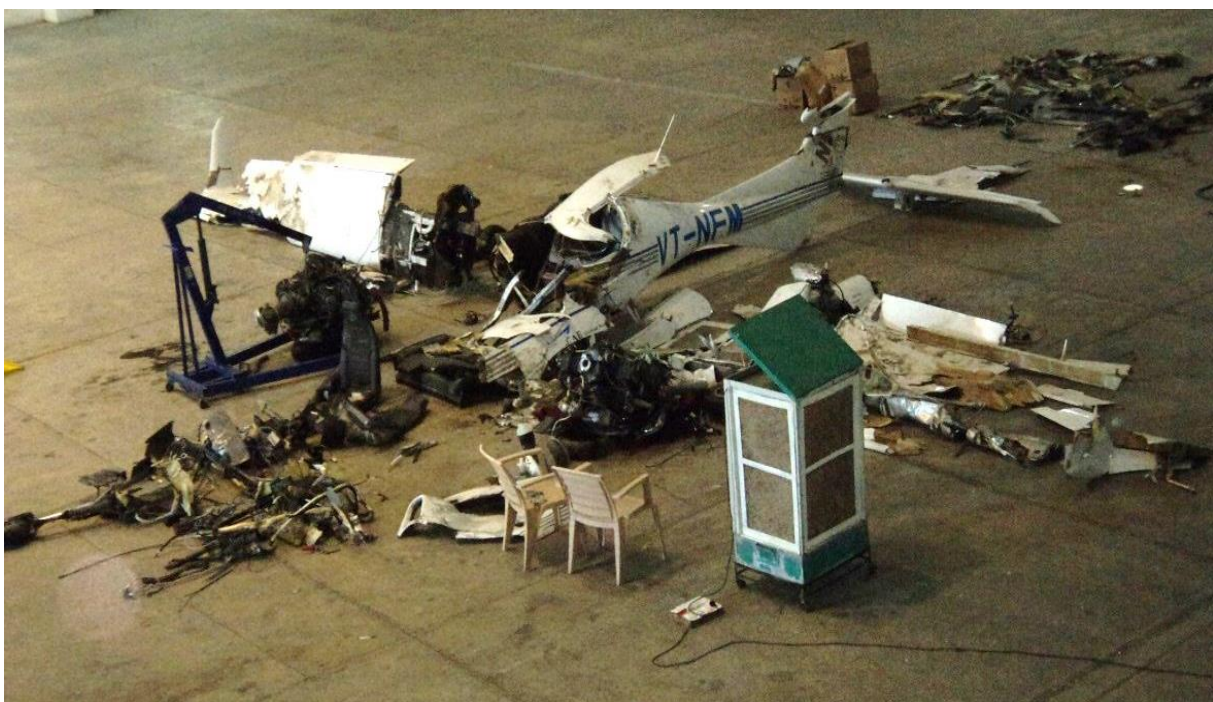

**Fig 7: Wreckage Layout at Gondia airport Hangar**

After impact the aircraft had disintegrated and scattered into mainly three major sections which were composed of main fuselage, engines and wings. The left wing was completely damaged and only fuel filler section along with fuel tank was recovered.



**Fig 8: LH wing wreckage after layout**

The right wing was also detached but was lying near the fuselage. The fuel tanks were also recovered in damaged condition and wing was broken into two sections.



**Fig 9: RH wing wreckage after layout**

The front portion of fuselage structure was badly damaged due to impact with ground and ropeway cable. The canopy was sliced by the ropeway cable. Front as well as rear seats were detached from the fuselage after impact.



**Fig 10: Front Fuselage wreckage**

Vertical stabilizer was also sliced by the ropeway cable. The rudder was damaged and rudder push rod was seen hanging from the ropeway cable and could not be retrieved.

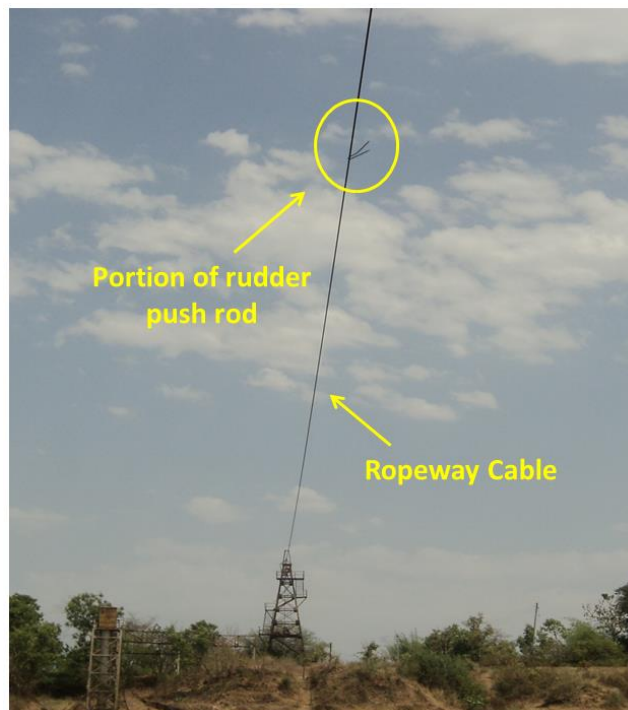

**Fig 12: Portion of rudder stuck in Ropeway cable**

Horizontal stabilizer was found in one piece but detached from the vertical stabilizer. The tail section was found mainly intact with some damages due impact.



**Fig 11: Wreckage of vertical stabilizer**

Due to impact the right landing gear was pushed into the wheel well and left gear & nose gear had disengaged from the gear bay and linkages.



**Fig 13: Landing gears at crash site**

Both the engines completely detached from airframe. The left propeller hub had got disconnected from engine and blades had completely sheared off from the root. The right propeller hub was attached with the engine and blades were sheared off at the root except for one blade which had about one feet blade remaining.



**Fig 14: Engines at crash site**

Further comparison of the wreckage was done with the serviceable aircraft and it was seen that, the direction of impact on the canopy was in line with the direction of impact on the vertical stabilizer as seen in the fig below.



**Fig 15: Comparison of wreckage with serviceable aircraft**

At the wreckage site, the vertical and horizontal stabilizer tail portion was found near to the ropeway cable along with pieces of canopy. The LH engine was found little further after crossing the boat. The Nose LG, LH LG, RH Engine, RH wing and tail section were all piled at one area ahead of LH engine. The ballast weights got thrown even further on the river bed about 200 metres away from the initial point of impact with ropeway cable.

### **1.13 Medical and pathological Information:**

The student pilot had reported for pre-flight medical at 0225 UTC and for the Instructor pre-flight medical test was carried out at 0337 UTC. After the accident the dead bodies of the crew were taken to Hospital. Head Injury was reported as the cause of death.

The viscera samples were sent to the Institute of Aerospace Medicine, Bangalore for further examination. The examination of viscera samples did not indicate any evidence of Carbon Monoxide Poisoning or presence of alcohol.

### **1.14 Fire:**

The aircraft took off with 288 litres of fuel. The aircraft flew for only about eight minutes before crashing. Therefore aircraft contained significant quantity of fuel on-board at the time of impact. The impact with the river bed had caused the fuel tanks to explode.

The witnesses reported seeing black smoke going up in sky; however there were no burn marks on the wreckage. The shallow water on the river bed possibly curtailed the fire.

### **1.15 Survival aspects:**

The aircraft hit a 02 inch thick steel rope, possibly at speed of about 80 to 90 Kt considering statements of witnesses which hints at a level flight. The canopy and tail of the aircraft was sliced by the rope and fatally injured both the crew. The accident was not survivable.



## 1.16 Tests and research

### 1.16.1 Engine Strip Examination:

Both the engines of the aircraft were retrieved from the wreckage site and transported to DGCA approved maintenance facility for inspection. Both the engines were stripped and detailed examination of engines was carried out.

The **LH engine** had Sr. No. L-32168-51E. Following were the observations of the detailed inspection of the LH engine:

The fuel pump was found dislodged from its position and hanging on fuel lines. Cylinder fins were found damaged.



**Fig: 18: Damaged Cylinder**

Seven quantities of spark plugs out of eight were retrieved from the wreckage site. The remaining spark plug possibly had dislodged from its position due to impact. The condition of the spark plugs was satisfactory. The helicoil of missing spark plug was found dislodged from its position.



**Fig:19: Dislodged Helicoil**

Inspection of Magnetos confirmed satisfactory condition of LH magneto, however the RH magneto was giving spark at a higher RPM.

Engine was disassembled for inspection. Carbon deposits were seen on the internal wall of cylinders, no deposits were noticed on Oil screen. High amount of carbon deposit was found in the ring grooves of Pistons. Carbon deposits were also noticed on dome of Piston. Piston rings of all the pistons were found in stuck piston without any movement and were corroded.



**Fig 20: Piston and Cylinders**

There was no visible damage to the gears.

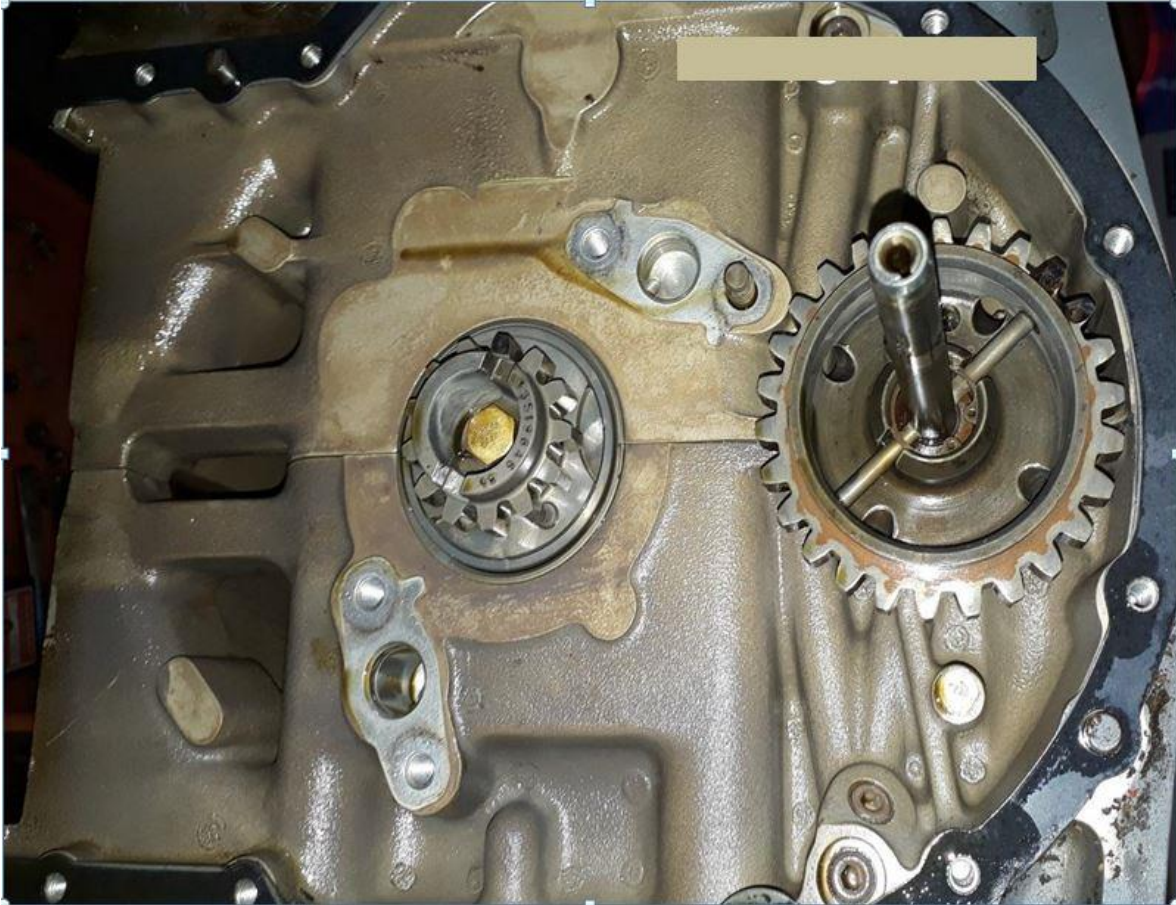

**Fig:21: Gears**

The Pushrods were bent.

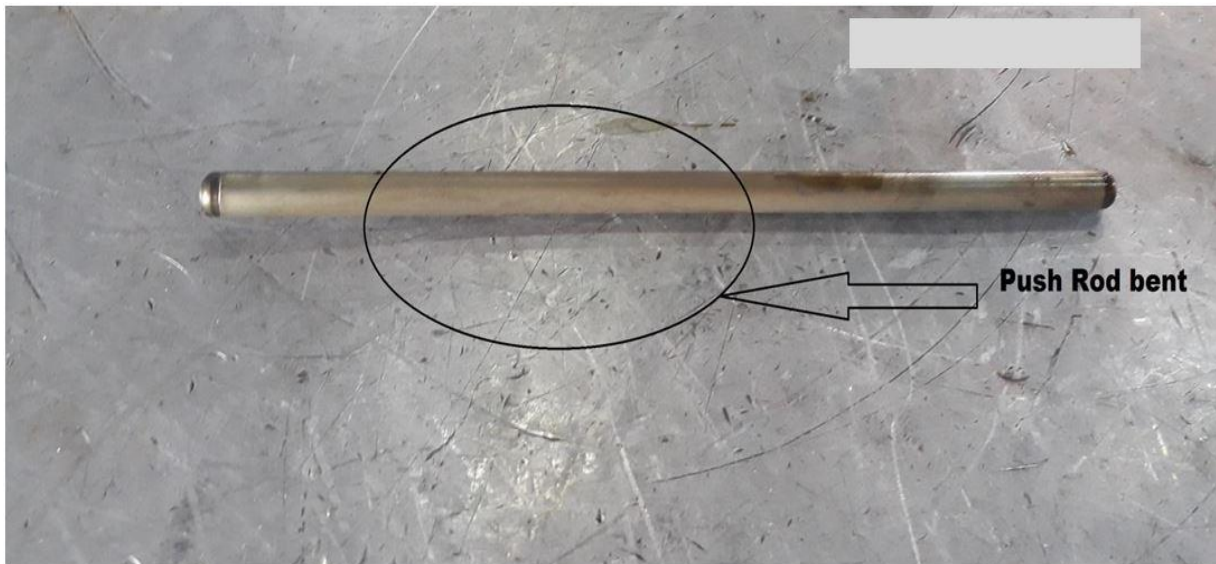

**Fig: 22: Damaged push rods**

The Crankshaft had sheared behind the flange. The condition of connecting rods with the bearing was satisfactory. No abnormal wear out or scuffing of bearing was found.



**Fig: 23: Failed crankshaft**

During Inspection of electrical system it was found that Ignition Harness was cut and damaged. Starter was found broken at the base.

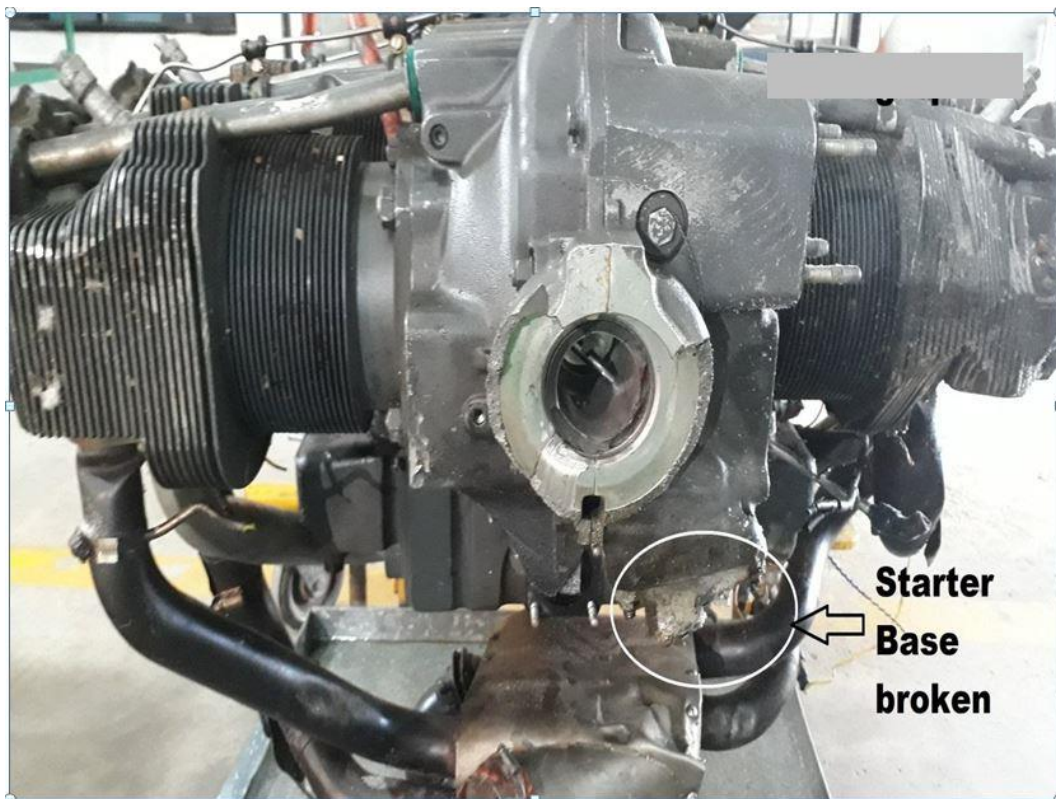

**Fig: 24: Starter base broken**

The inspection of fuel system revealed that the external condition of Fuel flow divider was satisfactory. The outlet elbow was broken. The fuel pump was

dislodged from its mounting and broken. Fuel injectors were missing and fuel lines were bent and dry.

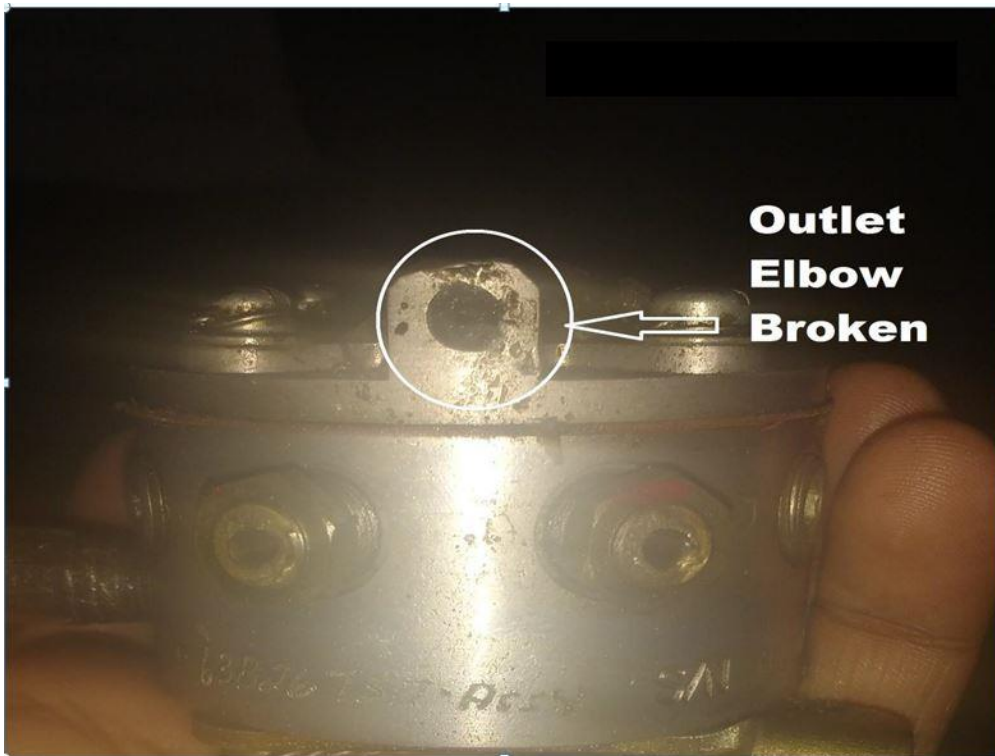

**Fig: 25: Broken fuel outlet elbow**

The oil filter adapter was broken and oil filter was missing.



**Fig: 26: Broken oil filter adapter**

From the investigation of engine it was seen that, there was no major damage to the internal parts of the engine except the crankshaft which had sheared off.

The external damages observed on parts and accessories were resultant of impact on the engine due accident .The carbon deposits noticed on piston were normal and are also normally observed on engines received for overhaul. The bench check of spark plugs was found satisfactory.

The sand particles seen at electrode locations of the spark plugs & internal walls of the cylinders were possibly due to ingestion of sand particles through the broken induction tube at the time of accident. The start of spark of right hand magneto at higher RPM was possibly due to change in time setting because of impact on magneto at the time of accident.

The **RH engine** was also stripped for detailed examination. The RH engine had serial number L-1144-67E. The following observations were made during the detailed examination of RH engine.

Propeller hub was attached to the flange of crankshaft and root section of propeller blades were stuck in the hub.

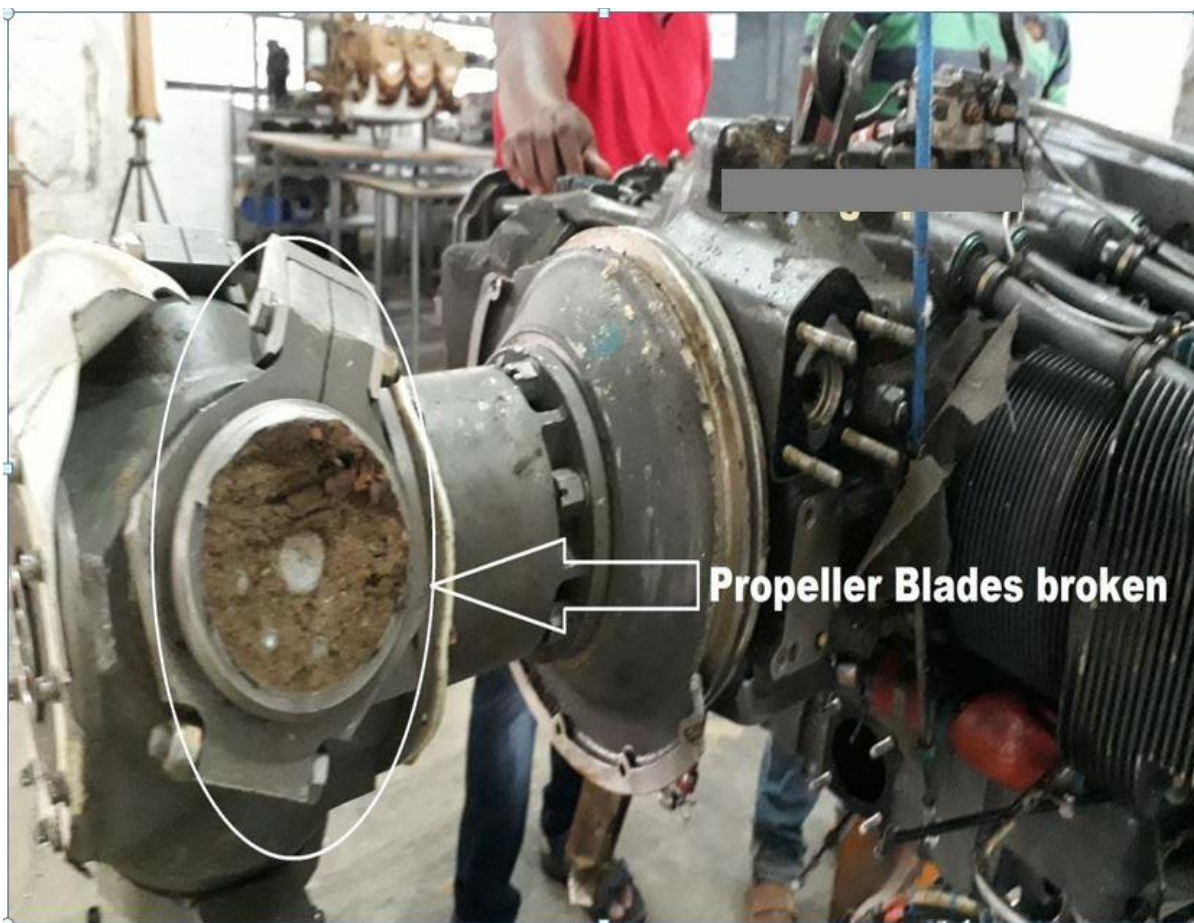

**Fig: 27: Sheared propeller blade**

The fins of all the four cylinders were damaged



**Fig: 28: Damaged Cylinder Fin**

The fuel pump was broken and detached from the engine.



**Fig: 29: Broken fuel pump**

Starter ring gear was broken.



**Fig: 30: Broken starter ring gear**

During examination of electrical system, all the spark plugs were intact and their condition was satisfactory. However, Ignition Harness was broken and damaged. Magnetos disintegrated from the engine. During bench check, condition of right and left magneto was found satisfactory.

Fuel System inspection revealed that fuel injector got detached and the external condition of fuel flow divider was not satisfactory. Fuel lines attachment was broken. Fuel pump was also broken. The Fuel lines were bent and dry.



**Fig: 31: Broken fuel lines**



During inspection of the dis-assembled right engine, high amount of carbon deposit was found in the ring grooves of Pistons and carbon deposits were noticed on dome of the Piston. Piston rings of all the pistons were found in stuck piston without any movement and corroded.



**Fig: 32: Piston and Cylinders**

The condition of Crankshaft and connecting rod bearing was inspected after disassembly and there was no abnormal wear out or scuffing marks on the bearing. Crankshaft was checked for freedom of rotation and found satisfactory.

The oil filter was cut opened and no metal particle was found. No internal damages noticed on Crank Case & Oil Sump casings. No deposit was noticed on Oil screen.



**Fig: 33: Oil filter cut for inspection**

There was no visible sign of damage on the gears.

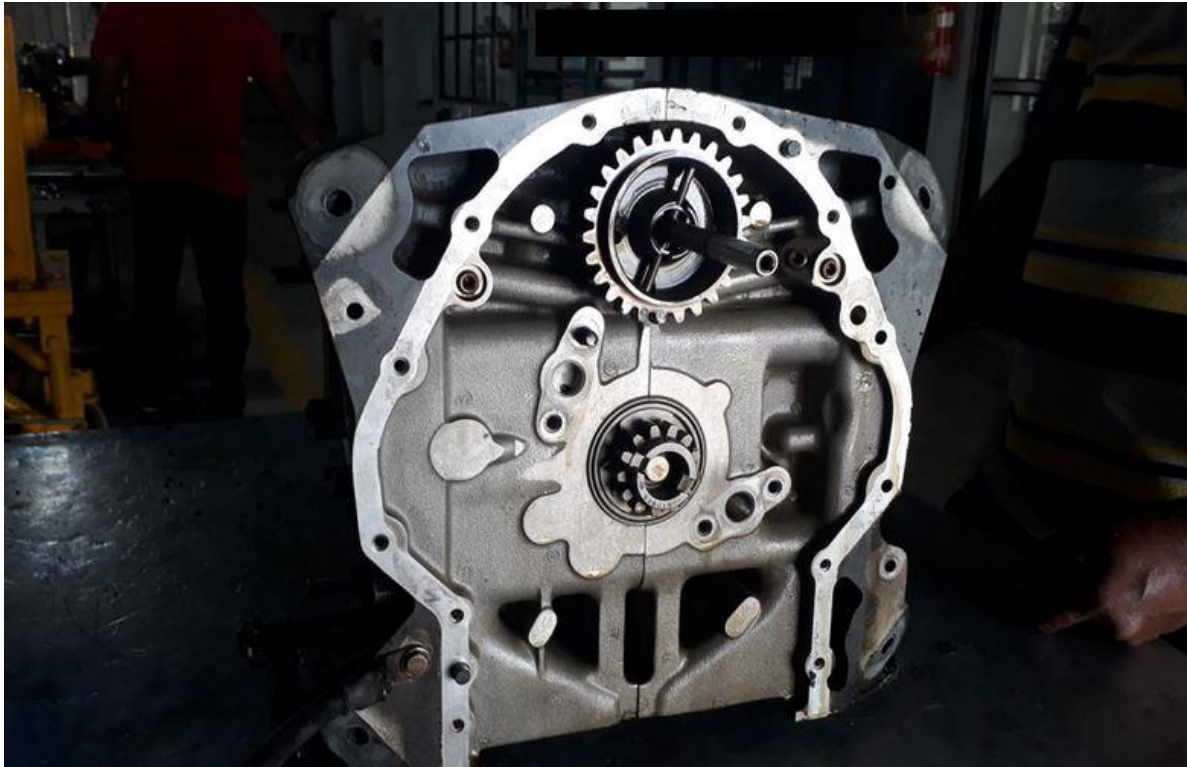

**Fig: 34: Gears**

All the Push rods shroud tubes of right engine were bent.



**Fig: 35: Bend shroud tubes**

From the detailed inspection of RH engine, it was observed that, there was no major damage to the internal parts of the RH engine as well. The external damages observed on parts and accessories were due to the impact on the engine

due to accident. The carbon deposits noticed on piston dome were normal and similar to those observed on engines received for overhaul. Propeller hub was found attached to the flange of crankshaft. The blades of propeller were found stuck in the hub.

## **1.17 Organizational and management information:**

### **1.17.1 National Flying Training Institute**

National Flying Training Institute (NFTI) is a joint venture between CAE Inc. and Airport Authority of India (AAI) and was established in 2007. Academy provides ab-initio training to pilots. It operates from AAI's Gondia airport located at Birsi Village in Gondia, Maharashtra.

NFTI had a fleet comprised of 12 glass cockpit DA40 aircrafts and two DA 42 aircraft at the time of accident. NFTI has been established primarily to provide integrated flying and ground training to students towards obtaining the following Flying Licenses, Ratings and other flying qualifications:-

- Issue/Renewal/Extension of Student Pilot License & FRTOL(R)
- Issue/Renewal/Extension of Private Pilots Licenses (Aeroplane)
- Issue/Renewal/Extension of Commercial Pilots License (Aeroplane)
- Issue/Renewal/Extension of Airline Transport Pilots License (Aeroplane)
- Issue/Renewal/Extension of Instrument Rating on Single & Multi-engine aircraft
- License Renewal & Foreign License Conversion Training
- Issue/Renewal of AFI Patter Training & Competency Checks
- Issue/Renewal of FI Patter Training & Competency Checks

The organisation chart of NFTI is as given below;

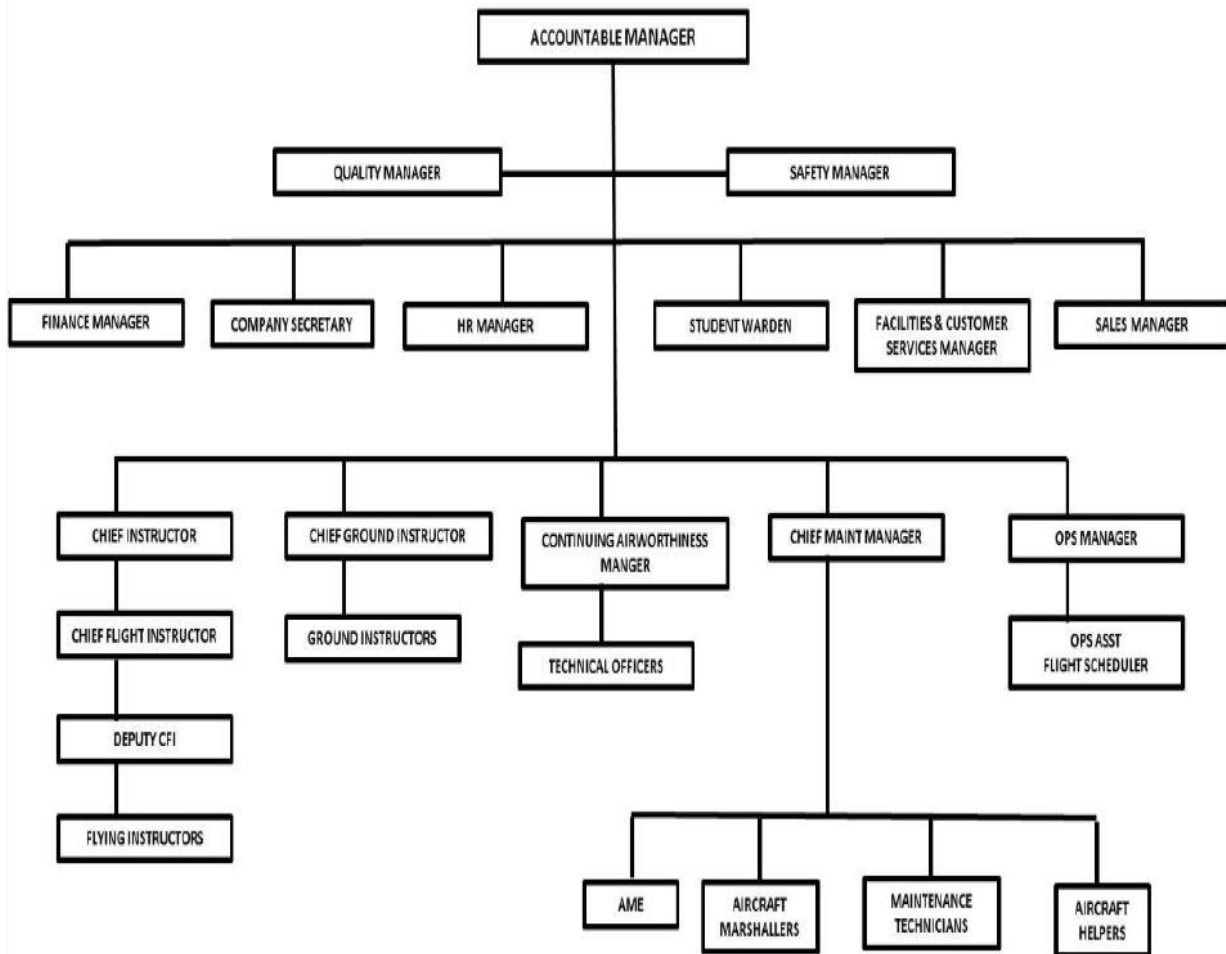

**Fig: 36: NFTI Organistaion Chart**

### 1.17.2 Policy and Procedure

NFTI uses DGCA approved Training and Procedure Manual for carrying out flying training. Apart from the Training and Procedure Manual, NFTI has also issued Standard Operating Procedures for day to day operations.

The SOP stipulates the circuit leaving procedure for operating from Gondia Airport, as per the procedure;

*“ATC will give instructions for departure for aircraft proceeding to sectors. All aircraft leaving circuit are to turn left/right by 90° after takeoff as ordered and clear out of the circuit area at the stipulated height before intercepting the sector radial. Turn to intercept the outbound radial may be commenced between 4-6 nm from the airfield on DME/ GPS. The radial must be established by 8nm from the airfield.”*

The weather minima, for dual flights, are stipulated in the Training and Procedures Manual (TPM) and are shown below.

- **Weather Minima for Dual Flights.** Applicable to dual flight, SPIC flights or any flight where an instructor is PIC.

WEATHER MINIMA FOR <u>DUAL</u> FLIGHTS					
TYPE OF FLIGHT	VISIBILITY	CLOUDS	WIND	CROSSWIND	TAILWIND
VFR SE DAY – LOCAL	1500 m	1500 ft	30 kts	20 kts	5 kts
VFR SE DAY – CROSS COUNTRY & NIGHT	*Day-1500 m Night-3000m	*Day-1500 m Night-No clds Below 500 ft.	30 kts	20 kts	5 kts
VFR ME DAY – LOCAL	1500 m	1500 ft	30 kts	17 kts	10 kts
VFR ME DAY – CROSS COUNTRY & NIGHT	*Day-1500 m Night-3000m	*Day-1500 m Night-No clds Below 300 ft.	30 kts	17 kts	10 kts
IFR TAKEOFF SE	Published Minima	No clouds below 500 ft	30 kts	20 kts <sup>(4)</sup>	5 kts
IFR APPROACH & LANDING SE	Published Minima	No clouds below 500 ft	30 kts	20 kts <sup>(4)</sup>	5 kts
IFR APPROACH & LANDING ME	Published Minima	No clouds below 300 ft	30 kts	17 kts	10 kts

- The wind, crosswind and tailwind values shall be referenced from the active runway – the steady wind factor + gust factor, reported or observed
- Cloud height indicates no observed or reported Overcast (OVC) or Broken (BKN) cloud layers below the designated value unless specified otherwise
- Cloud height references are Above Ground Level (AGL)
- DA40 crosswind limit is 20 kts and DA42 is 17 Kts

Fig: 37: Weather Minima prescribed in TPM

### 1.17.3 Safety Reporting

NFTI has laid down procedure for Hazard Identification and Analysis in its Safety Management System (SMS) Manual. Safety Reporting Forms i.e. Occurrence Reports, Hazard Reports, Voluntary Reports (VOLREPS) are used for purpose of hazard identification and safety reporting.

Boxes are provided at various locations, where voluntary reports can be dropped. There was no evidence of any voluntary reports gathered before

September 2016, however from September 2016 to the date of accident total of 11 voluntary reports were gathered by NFTI Safety Department. These reports mainly concerned housekeeping and routine matters. *"To measure awareness of and the willingness to report hazards by all company employees."* is one of the performance goal laid in SMS Manual.

There was no report by any student pilot of dangerous flying with the deceased Instructor or any other instructor even though cadet pilots had flown sorties with the Instructor where assigned flight level were breached and low flying was carried out.

### 1.18 Additional Information:

#### 1.18.1 Aircraft Performance data:

The airplane flight manual for DA-42 was examined for studying the performance limitations of DA-42 aircraft. The following table provides the Airspeed Indicator Markings which are available in the cockpit for warning the crew about the speeds.

### 2.3 AIRSPPEED INDICATOR MARKINGS

Marking	KIAS	Significance
White band	57 - 111 KIAS	Operating range with flaps fully extended.
Green band	64 - 155 KIAS	Normal operating range.
Yellow band	155 - 194 KIAS	'Caution' range - "Only in smooth air".
Blue band	90 KIAS	Best rate of climb speed, single engine.
Red band	65 KIAS	Minimum control speed, single engine.
Red band	194 KIAS	Maximum speed for all operations $V_{NE}$ .

**Fig 38: Airspeed Indicator Marking**

The following table provides the limits for different airspeeds as mentioned in the Airplane Flight Manual.

	Airspeed		IAS	Remarks
V <sub>A</sub>	Maneuvering speed	above 3400 lbs (1542 kg)	126 KIAS	Do not make full or abrupt control surface movements above this speed
		up to 3400 lbs (1542 kg)	120 KIAS	
V <sub>FE</sub>	Max. flaps extended speed	LDG	111 KIAS	Do not exceed these speeds with the given flap setting
		APP	137 KIAS	
V <sub>LE</sub>	Max. landing gear extended speed		194 KIAS	Do not exceed this speed with the landing gear extended
V <sub>LO</sub>	Max. landing gear operating speed	Extension	V <sub>LOE</sub> 194 KIAS	Do not operate the landing gear above this speed
		Retraction	V <sub>LOR</sub> 156 KIAS	
V <sub>MCA</sub>	Minimum control speed airborne		65 KIAS	With one engine inoperative, keep airspeed above this limit
V <sub>NE</sub>	Never exceed speed in smooth air		194 KIAS	Do not exceed this speed in any operation
V <sub>NO</sub>	Max. structural cruising speed		155 KIAS	Do not exceed this speed except in smooth air, and then only with caution
V <sub>SSE</sub>	Minimum Control Speed for Safe single engine training		80 KIAS	Minimum speed authorized in case of one engine intentionally inoperative/idle (training purposes)
V <sub>YSE</sub>	Best Rate-of-Climb Speed		90 KIAS	Best rate-of-climb speed on one engine

**Fig 39: Different airspeeds limits as per Airplane Flight Manual**

### 1.18.2 ATC Transcript

The transcript of ATC conversation was prepared and some relevant extracts from the transcript are given below.

TIME (UTC)	CALL SIGN	CONVERSATION
03:44:03	VTNFM	<i>GONDIA TOWER VICTOR FOXTROT MIKE REQUEST START UP FOR GENERAL FLYING POB ZERO TWO PIC CAPTAIN RANJAN PEE THREE CADET HIMANI ETD ZERO THREE THREE ZERO DURATIONZERO ONETWO ZERO ENDURANCE ZERO FIVE THREE ZERO FIC ZERO ONE FIVE EIGHT ADC NOVEMBER SEVEN ONE EIGHT</i>
03:44:22	TOWER	<i>VICTOR FOXTROT MIKE TOWER VISIBILITY FOUR THOUSAND METER</i>
03:44:26	VTNFM	<i>NAMASKAAR SIR REQUEST START UP UNDER SPECIAL VFR VICTOR</i>

		<i>FOXTROT MIKE</i>
<b>03:44:30</b>	<b>TOWER</b>	<i>VICTOR FOXTROT MIKE TOWER START UP APPROVED UNDER SPECIAL VFR RUNWAY ZERO FOUR</i>
<b>03:50:06</b>	<b>VTNFM</b>	<i>TOWER VICTOR FOXTROT MIKE REQUEST SECTOR CLEARANCE, PREFERENCE SECTOR WEST</i>
<b>03:50:11</b>	<b>TOWER</b>	<i>VICTOR FOXTROT MIKE TOWER, CLEARED FOR GENERAL FLYING IN SECTOR WEST, AFTER DEPARTURE RUNWAY ZERO FOUR CONTINUE TO TWO THOUSAND FIVE HUNDRED FEET, TURN LEFT TO ESTABLISH TWO SIX FIVE RADIAL GOLF DELTA ALPHA, FURTHER CLIMB TO FIVE THOUSAND FEET</i>
<b>03:50:23</b>	<b>VTNFM</b>	<i>CLEARED FOR SECTOR WEST, CLIMB RUNWAY HEADING TWO THOUSAND FIVE HUNDRED, TURN LEFT INTERCEPT RADIAL TWO SIX FIVE, FURTHER CLIMB TO FIVE THOUSAND VICTOR FOXTROT MIKE</i>
<b>03:53:35</b>	<b>TOWER</b>	<i>VICTOR FOXTROT MIKE TOWER RUNWAY ZERO FOUR CLEARED FOR TAKE OFF WIND THREE FOUR ZERO DEGREES ONE ONE KNOTS UPWIND TRAFFIC FOR CIRCUIT</i>
<b>03:53:37</b>	<b>VTNFM</b>	<i>CLEARED FOR TAKE OFF UPWIND TRAFFIC MONITORED VICTOR FOXTROT MIKE</i>
<b>03:57:32</b>	<b>TOWER</b>	<i>VICTOR FOXTROT MIKE STOP CLIMB FOUR THOUSAND</i>
<b>03:57:35</b>	<b>VTNFM</b>	<i>STOP CLIMB FOUR THOUSAND VICTOR FOXTROT MIKE, WE HAVE INTERCEPTED RADIAL TWO SIX FIVE AND THREE MILES OUT</i>
<b>03:57:46</b>	<b>TOWER</b>	<i>VICTOR FOXTROT MIKE STOP DESCEND FOUR THOUSAND</i>
<b>03:57:51</b>	<b>VTNFM</b>	<i>LEVEL FOUR THOUSAND NOW MAM VICTOR FOXTROT MIKE</i>
<b>03:59:58</b>	<b>VTNFM</b>	<i>VICTOR FOXTROT MIKE FOUR THOUSAND TWO SIX FIVE TEN MILES OUT</i>
<b>04:00:04</b>	<b>TOWER</b>	<i>VICTOR FOXTROT MIKE TOWER CLIMB TO FIVE THOUSAND FEET AND OPERATE BETWEEN ONE SEVEN TO TWO FIVE NAUTICAL MILES GIVE ALL OPS NORMAL IN EVERY ONE ZERO MINUTES</i>
<b>04:00:13</b>	<b>VTNFM</b>	<i>CLIMB TO FIVE THOUSAND OPERATE ONE FIVE TO TWO FIVE CALL OPS NORMAL ONE ZERO VICTOR FOXTROT MIKE</i>
<b>04:03:20</b>	<b>TOWER</b>	<i>VICTOR FOXTROT MIKE TOWER TRAFFIC COMPANY AIRCRAFT VICTOR FOXTROT KILO GONDIA TO NOVEMBER NOVEMBER PAPA WILL ESTABLISH TWO FOUR FIVE RADIAL GOLF DELTA ALPHA WILL CLIMB TO FLIGHT LEVEL EIGHT ZERO</i>
<b>04:03:40</b>	<b>TOWER</b>	<i>VICTOR FOXTROT MIKE GONDIA TOWER CONFIRM COPIED</i>

The aircraft was given take-off clearance at 03:53:35 UTC and took-off from RWY 04. The last contact from VT-NFM was at 04:00:13 UTC. At 04:03:20 ATC contacted VT-NFM to provide traffic information however there was no response from VT-NFM, and ATC did not call after that. After receiving information about the crash, the ATC again tried contacting VT-NFM at 04:22:52 UTC, but got no response. At 05:13:34, another company aircraft VT-NFC confirmed seeing wreckage of VT-NFM.



### 1.18.3 DGCA Flying Grant Circular No 2/2005

The operator quoted DGCA Flying grant circular No. 2/2005 dated 12.04.05 to allow flights under Special VFR. The minima prescribed in the training manual approved by DGCA are also as per minima prescribed in the said circular.

As per the circular, the operations under special VFR are permitted, “*at the discretion of CFI/FII who should be physically present during all such flying training operations.*”

The CFI was not present on the day of accident and flying was authorised by the Dy. CFI as per para 2.2 of CAR Section 7, Series I, Part V, which stated that, “*In absence of CFI, Dy DFI shall be overall in-charge of the flying training activities.*”

### 1.19 Useful or effective investigation techniques

As per the circuit leaving procedure being followed by NFTI at Gondia, all aircraft leaving circuit are to turn left/right after take-off and clear out of the circuit area at stipulated height before intercepting sector radial. The turn to intercept outbound radial is required to be commenced between 4-6 NM from airfield and radial must be established by 8 NM from the airfield.

The following table is prepared based on the position of aircraft reported by crew to ATC.

Sr .	Time (UTC)	Aircraft Position, as reported by crew to ATC.	Time elapsed from previous position
1	03:53:37	Rwy 04: Time of Take-off	---
2	03:57:35	Position(I) Altitude : 4000 feet Radial : 265° Distance from Gondia (DME) : 03 NM	238 sec
3	03:59:58	Position(II) Altitude : 4000 feet Radial : 265° Distance from Gondia (DME) : 10 NM	143 sec
4	04:00:13	Last call from VT-NFM	15 sec
<b>Total time taken from Rwy 04 to Position(II) = 381 sec</b>			
<b>Total time between from Rwy 04 to last call = 396 sec</b>			

The table gives the time elapsed between the reporting of position by the aircraft and also the total time taken from RWY 04 to Position (II) and the last call.

We can see from above table that the aircraft flew distance of 07 NM on radial R265 from Position (I) to Position (II) in 143 seconds. This would require the aircraft to fly at airspeed 176 Kt. This is way above the normal maximum structural cruising speed of 155 Kt.

Further, the aircraft took off from Rwy 04 and was required to continue to 2500 feet before turning left as per instructions of ATC. Assuming that the SOP was followed, aircraft would have turned left to intercept R265 between 04-06 NM from runway.



**Fig 40: Possible route as per ATC conversation (Depicted in red)**

Two scenarios were considered for investigation. In the **first scenario** the aircraft is assumed to have turned left at a distance of 04 NM to intercept radial R265, at 03NM from DME i.e. Position (I). The distance travelled to Position (I) from RWY 04 comes out to be 9.82 NM in this case. The aircraft would require to fly at an average speed of 148Kt to travel from RWY 04 to Position (I) in 238 seconds.

The aircraft would have covered approximately 16.82 NM by the time it reached 4000 feet on radial R265 at 10NM (Position (II)), after take-off from RWY 04 in total of 381seconds. The average speed required by aircraft to reach Position (II) from RWY 04 comes out to be 158 Kt in this case.

In the **second scenario** the aircraft is assumed to have turned left at a distance of 06 NM to intercept radial R265, at 03NM from DME i.e. Position (I). The distance travelled to Position (I) from RWY 04 comes out to be 13.72 NM in this case. This would require aircraft to fly at an average speed of 207 Kt to travel from RWY 04 to Position (I) in 238 seconds.

The aircraft would have covered approximately 20.72 NM by the time it reached 4000 feet on radial 265 at 10NM Position (II), after take-off from RWY 04 in total of 381 seconds. The average speed required by aircraft to reach Position (II) from RWY 04 comes out to be 195 Kt in this case.

Possible route followed by the aircraft when plotted on the map based on the sightings by the witnesses is given below.

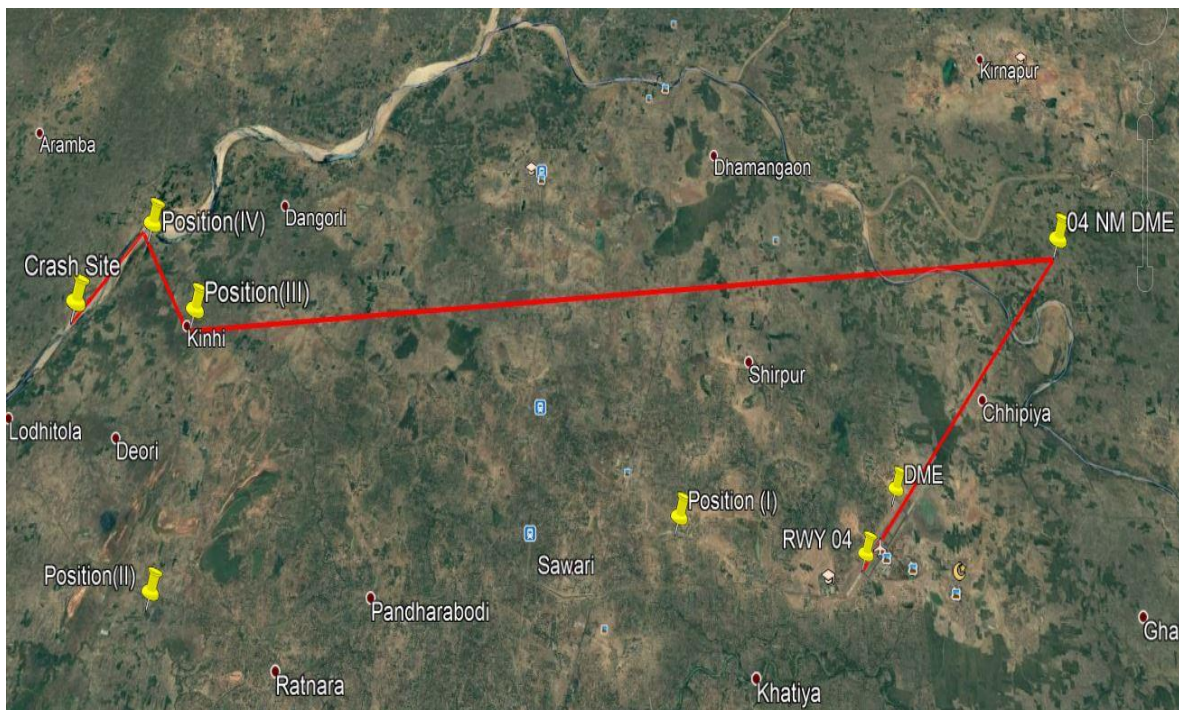

**Fig 41: Possible route as per witness and aircraft performance limits**

As per the statement of Assistant Flight Instructor, who was taxiing to holding point, he saw the aircraft take-off and turning to establish sector as per normal departure procedure. A witness at Position (III) saw aircraft overflying

heading towards the direction of river. Another witness near the river bank at Position (IV) saw the aircraft joining the river course headed over the river course.

If the above positions are plotted on the map, it is reckoned that, the aircraft would have covered a distance of approximately 15.78 NM from RWY 04 to crash site. Travelling at an average normal speed of 110Kts, this distance would be covered in 516 seconds. The time between the take-off and last call is 396 seconds. The aircraft possibly flew for another 02 minutes after last call before crashing on the river bed.

The possible time of crash was 04:02:13 UTC

## **2. ANALYSIS**

### **2.1 Serviceability of the aircraft:**

The aircraft had a valid Certificate of Airworthiness and a valid Certificate of Registration at the time of accident. The scrutiny of the Aircraft Log book revealed that the aircraft had completed 3248:05 hrs (TSN) as on 26th April 2017. The aircraft is powered by two Lycoming Engines. The LH engine had logged 3199:00 hrs (TSN), 1248:25 hrs (TSO) and RH engine had logged 4227:00 hrs (TSN), 1248:25 hrs since overhaul. Scrutiny of the aircraft records further revealed that all the modifications on the aircraft were found to be complied with at the time of accident. Prior to accident flight the aircraft weight & balance was well within the operating limits.

The last major inspection on the aircraft was carried out on 08.04.2017. The last scheduled inspection 50 Hrs/ 03 month was carried out on the aircraft on 24.04.2017. Aircraft did not have any pending snag and was neither operating under any MEL. Both the engines were serviceable and did not have any pending snags.

It can be inferred from the failure observed on the crankshaft during detailed examination of the LH engines that the shaft had failed due to torsional

shear indicating the engine was delivering full power at the time of accident. The other damages observed were resultant of impact to the engine at the time of accident.

Similarly the observation made during disassembly of RH engine revealed that engine was running and delivering full power at the time of accident. The damages observed on the engines were resultant of impact at the time of accident.

The aircraft was equipped with Garmin G1000 glass cockpit. As per the statement of AME, the facility for recording and downloading the flight parameters was not functional on the aircraft due to non upgradation of software. No data recording pertaining to the accident flight could be retrieved from the wreckage. This however was not contributory to the accident.

From the above it is inferred that serviceability of the aircraft was not a contributory factor to the accident.

## **2.2 Crew Qualifications:**

The instructor did not have FIR(A) required to operate flight as Flight Instructor. However, exemption was obtained by NFTI under Rule 160, for him to impart instructional flying training from DGCA. The instructor had however recently fulfilled the flying hour requirement for which exemption had been sought from DGCA, and his application for grant of FIR (Aeroplane) was pending with DGCA on the date of accident.

The student pilot had completed 198.5 Hrs of flying and was flying her last sortie to complete 200 Hrs of flying training for grant of CPL. Both crews were qualified for operating the flight.

## **2.3 Weather:**

As per the MET report, visibility at Gondia airport on the day of accident was 4000 m. The aircraft operated flight under Special VFR as permitted by DGCA Flying grant circular no 2/2005 dated 12.04.2005. However as required by the said circular, CFI was not physically present during flying on date of accident.

There was no significant change predicted in the Met reports. The visibility may be contributory factor, as it could have resulted in loss of situational awareness about the steel cable, causing the aircraft to hit the cable while flying at low height.

#### **2.4 Flight Data analysis:**

The aircraft was equipped with non WASS G1000 system software version 1054.00 to capture flight data. However the aircraft was unable to collect flight data due to non upgradation of software.

NFTI is operating another multi engine DA42 aircraft VT-NFO which is equipped with the same instrument and has the facility to capture flight parameters. The data for flights from previous months where the deceased Instructor had flown was analysed to observe for any discrepancy.

The random analysis of flight operated by deceased instructor revealed that he had earlier also flown low while performing dangerous manoeuvres during at least two of the analysed flights. These flights were dual flights with trainee pilots who incidentally were flying their last flight before completion of flying training. The same was also corroborated by the statements of a student pilot who flew in these flights.

#### **2.5 Circumstances leading to the accident:**

The aircraft took-off from RWY 04 at 03:53:37 UTC. Aircraft climbed to a height of 2500 feet and turned left at 04 NM. The aircraft did not follow the route advised by ATC and reported wrong positions to ATC while flying towards the river. The aircraft joined the river course at about 03 km from the crash site and flew low over the river before hitting the ropeway cable at about 04:02:13 UTC.

From the wreckage examination, it can be presumed that aircraft hit the ropeway cable in level attitude. The cable sliced the canopy and vertical stabilizer while fatally injuring the crew. The aircraft then pitched down and banked to the

left. The left wing first grazed a boat and then hit the riverbed, causing it to get completely crushed by impact and the LH engine got detached. The aircraft got thrown further with its cockpit hitting the riverbed and in the process getting completely destroyed and toppling the aircraft.

### **3 CONCLUSIONS**

#### **3.1 Findings**

- 1) Aircraft had a valid Certificate of Airworthiness and was certified and maintained in accordance with the approved maintenance schedule.
- 2) Flight Instructor was exempted by DGCA to impart instructional flying training, without FIR (A).
- 3) Student pilot was qualified to operate the flight and was flying her last sortie before meeting the requirement of 200 Hrs of flying training for issue of CPL.
- 4) Both the crews had valid medical and had undergone breath analyser test before operating the flight.
- 5) During pre-flight briefing crew obtained weather from ATC Gondia for 0330 UTC. As per the MET report the weather at the time of accident was visibility 4000 meters with winds 330/11 knots.
- 6) Flight was operated under Special VFR but it was in absence of CFI, in contravention of DGCA Flying Grants Circular no 2/2005 dated 12.04.2005.
- 7) VT-NFM was the third departure of the day from Gondia airport and flying was authorised by the Dy. CFI in absence of CFI.
- 8) The aircraft was given sector clearance at 03:50:11 UTC and was cleared for general flying in sector west, with instruction to continue to 2500 feet after departure from RWY 04 and turn left to establish radial R265GDA before further climb to five thousand feet.
- 9) The aircraft was cleared by ATC at 03:53:35 UTC for take-off from runway 04 for sector west radial R265 GDA.
- 10) At 03:57:35 UTC, crew reported intercepting radial R265 GDA at 03NM.

- 11) At 03:59:58 UTC, crew reported position 10 NM out on radial R265 GDA at height 4000 feet.
- 12) At 04:00:04 UTC ATC instructed crew to climb to 5000 feet and operate between 17 to 25 NM and report all operations normal at every 10 minutes. The call was acknowledged at 04:00:13 UTC.
- 13) At 04:03:20 UTC, ATC called the aircraft to advise traffic, however the crew did not copy back or give confirmation and there was no further call from ATC either.
- 14) ATC did not take any action when the aircraft did not acknowledge its call and did not report normal operations every 10 minutes as advised.
- 15) It is found from analysis of aircraft position viz-a-viz aircraft performance data, that aircraft was not flying at assigned level and was reporting wrong positions to the ATC.
- 16) Aircraft was flying low and joined the river course about 3 km away from the crash site.
- 17) Aircraft possibly crashed at 04:02:13 UTC, i.e about two minutes after the last call to ATC.
- 18) Aircraft hit a Rope-way cable, which sliced the canopy and tail of the aircraft, while fatally injuring the crew.
- 19) At approximately 0410 UTC, Flight Dispatcher at NFTI received a call about an aircraft crash near village Dhapewada.
- 20) Aircraft accident information was passed on to ATC. Subsequently at 0422 UTC, ATC tried calling the aircraft and repeated calls were given. However, no response was received.
- 21) Wreckage of the aircraft was located at 11.8 NM from Gondia on radial R281 on river bed of River Wainganga.
- 22) The flight data analysis of flights operated by deceased instructor revealed that instructor was involved in a few cases of low flying, breach of assigned level during the last sorties of some student pilots.
- 23) No student pilot or anyone ever reported instances of dangerous flying by the deceased crew through Safety Reporting System.
- 24) Aircraft had sufficient quantity of fuel and both the engines were running on full power at the time of accident.



### **3.2 Probable cause of the Incident:**

Accident was caused by crew not flying the assigned route and flying low over the river bed which resulted in the aircraft hitting a ropeway cable.

Lower visibility than VFR minima, may have been a contributory factor.

### **4. Recommendations:**

**4.1** DGCA must have a procedure for additional mitigation measures to ensure safety where-in exemption from regulatory requirement is granted under Rule 160.

**4.2** DGCA must revise Flying Grant Circular no. 2/2005 dated 12.04.2005 and CAR Section 7, Series I, Part V or any other regulation to remove ambiguity regarding presence of CFI during Special VFR operations.

**4.3** Operator should measure and ensure improvement in awareness and willingness of its staff to report hazards and safety issues, without any fear or hesitation.

**4.4** All flying training organisations should devise method for random/periodic monitoring of flights to check if flight path flown by their trainee pilots and instructors are as per flight authorisation.

**4.5** ATC should apprise its controller of need to continuously monitor aircrafts, especially in airspaces not under radar surveillance.

**4.6** ATC in consultation with DGCA may devise methodology to report suspected cases of breach of ATC instructions in areas not under radar surveillance.



(Jasbir Singh Larhga)  
Chairman, Committee of Inquiry



(Dinesh Kumar)  
Member, Committee of Inquiry

Date : 07.08.2018

Place : New Delhi